

# ISL95871CEVAL3Z Evaluation Board Setup Procedure

The ISL95871C is a highly integrated battery charger controller for Li-ion/Li-ion polymer batteries with SMBus interface controlling charge voltage, charge current and input current limiting. The ISL95871CEVAL3Z evaluation board includes a USB to SMBus interface to allow users to control the ISL95871C from a Personal Computer.

## What's Inside

This Evaluation Board Kit contains the following materials:

- Qty (1) ISL95871CEVAL3Z Evaluation Board
- Qty (1) USB cable

## What is Needed

The following materials are recommended to perform testing:

- One adjustable 25V 6A power supply
- Two adjustable electronic loads with constant current mode and constant voltage mode.
- One Volt Meter
- One 500MHz four-channel oscilloscope with voltage and current probes
- A Personal Computer (PC) with ISL95871C control software and drivers (all available on the self extracting archive file ISL95871C\_v2.1\_Installer.exe available for download from [www.intersil.com](http://www.intersil.com))

Note: The National Instruments Runtime Engine must be installed before connecting the evaluation board to your PC. The Runtime Engine contains driver files required by the New Hardware Wizard.

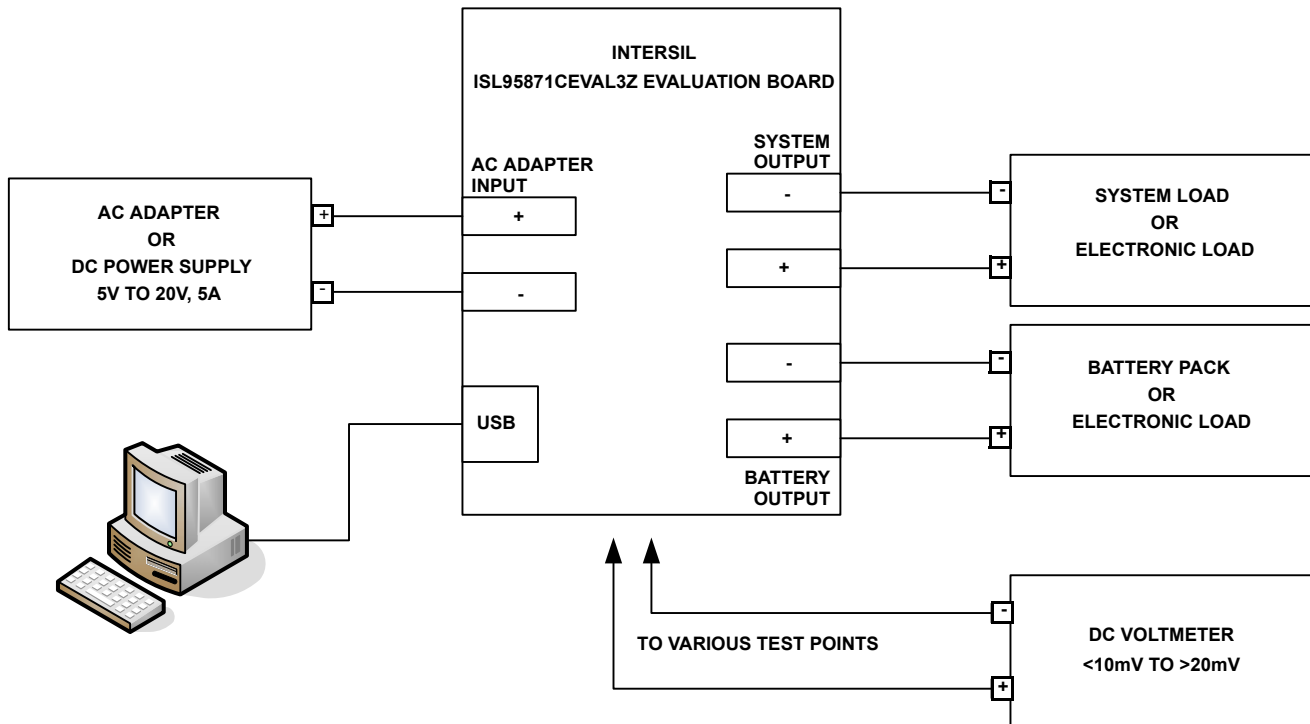

FIGURE 1. ISL95871C EVALUATION BOARD HARDWARE CONNECTION DIAGRAM

# Application Note 1590

## Install the Software

Insert the CDROM in the PC that you will use to control the evaluation board. It may run the Autorun program shown in Figure 2 automatically. If it does not, navigate to the folder and double click the

“Autoexec.exe” file. You should see the window as shown in Figure 2.

Click on the “Install or Uninstall ISL95871C Control Software” to run the Installation Wizard.

You should now see a window as shown in Figure 3.

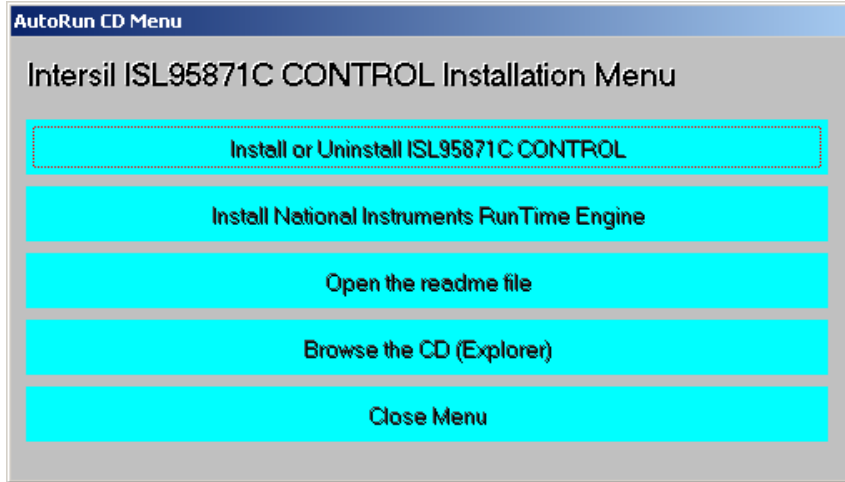

FIGURE 2. ISL95871C CONTROL SOFTWARE INSTALLATION MENU



FIGURE 3. ISL95871C CONTROL SOFTWARE INSTALLATION WIZARD

## Application Note 1590

In most PCs the National Instruments Runtime Engine will be installed automatically after the ISL95871C software. You should see the window as shown in Figure 4.

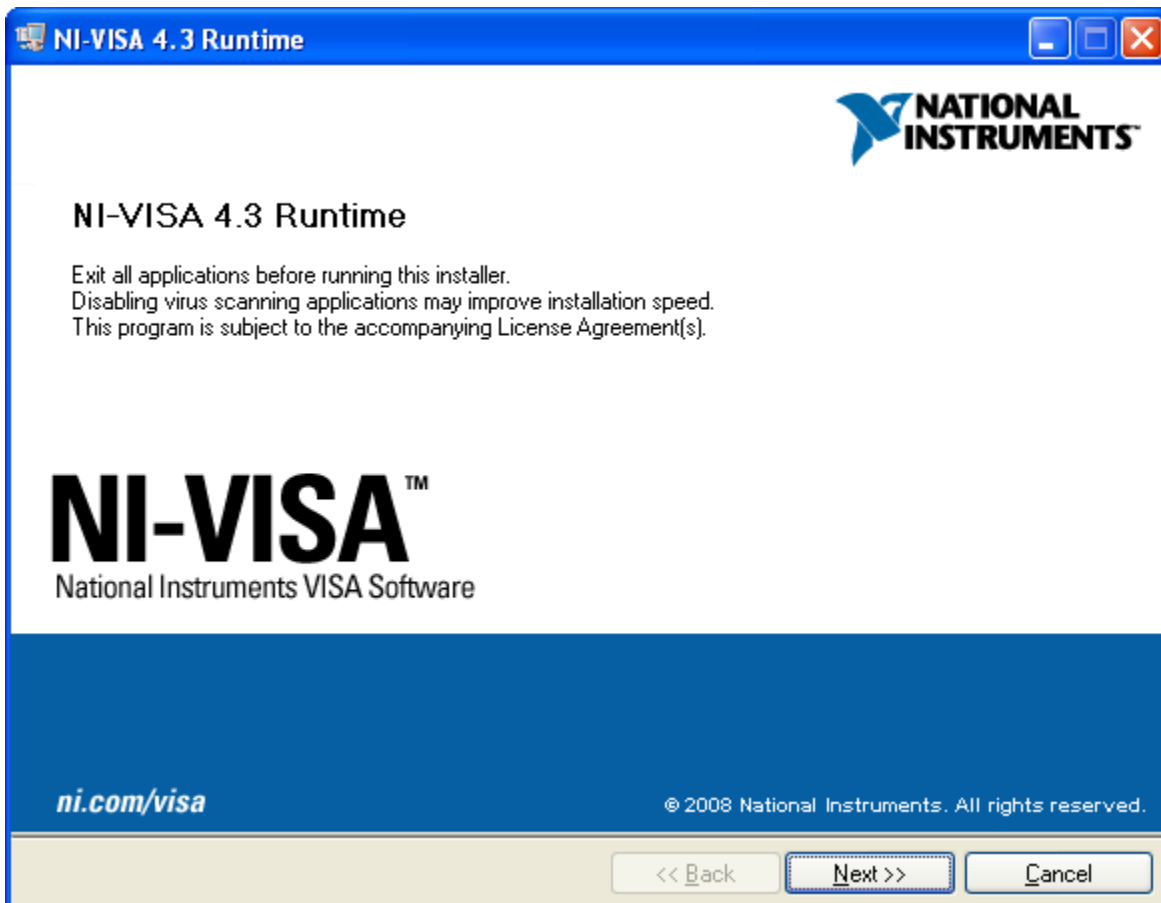

**FIGURE 4. NATIONAL INSTRUMENTS RUNTIME ENGINE INSTALLATION WIZARD**

Follow the instructions to install the Runtime Engine. If it does not run automatically, click "Install National Instruments Runtime Engine" on the ISL95871C Control Software Installation Menu (see Figure 2 on page 2). After installation, click on the Close Menu button.

# Application Note 1590

## Driver Installation

After installing the National Instruments Runtime Engine, connect the ISL95871C evaluation board to the USB port of your PC.

Note: The SMBus part of the ISL95871C and the USB-SMBus interface are powered by the 5V from the USB port on the PC. It is not necessary to have other power supplies connected to the evaluation board to read or write to the ISL95871C.

When WINDOWS detects new hardware, the new hardware wizard should appear. Direct it to look for the driver information file in the "ISL95871C Installer" folder (extracted from the downloaded file).

In some systems, it may be necessary to specify the driver information file (USB-I2C\_WDM.inf).

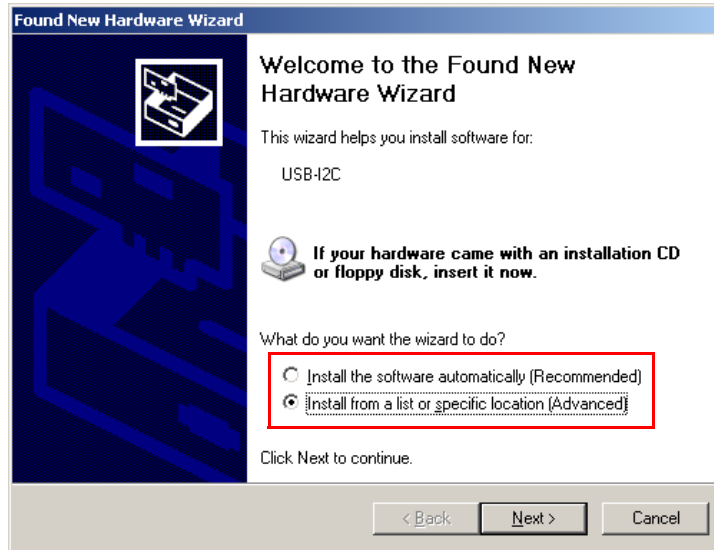

FIGURE 5. SELECT INSTALL FROM A SPECIFIC LOCATION

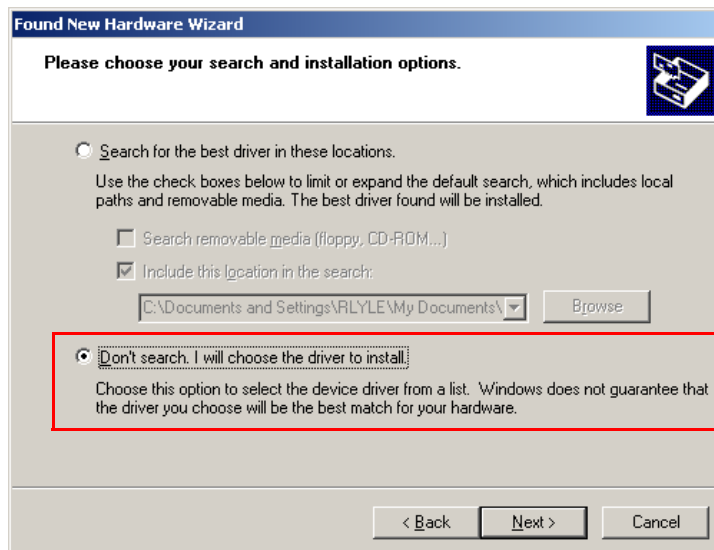
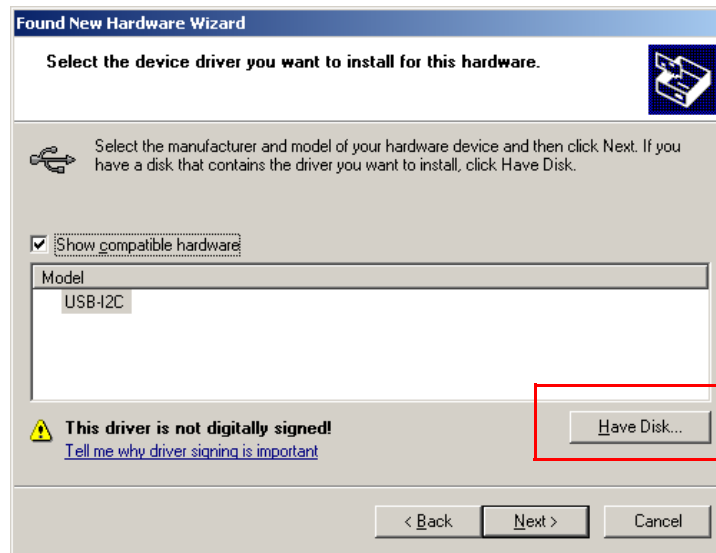
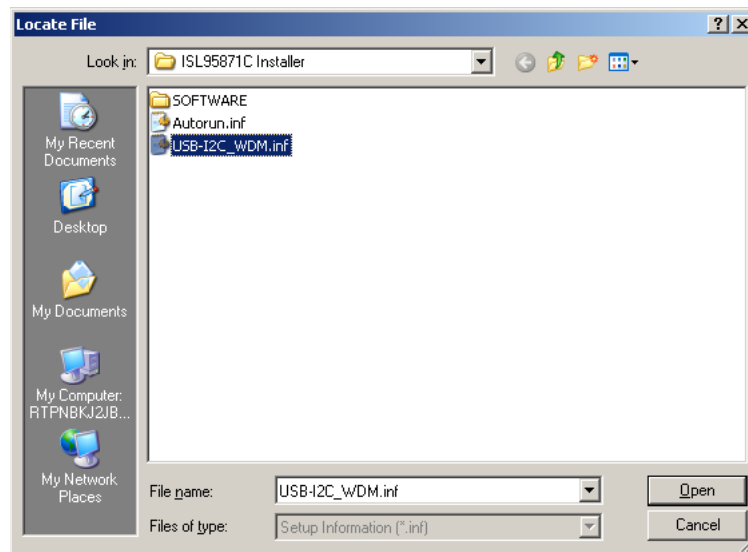

FIGURE 6. SELECT DON'T SEARCH



**FIGURE 7. CLICK ON THE "HAVE DISK" BUTTON**



**FIGURE 8. BROWSE TO THE FOLDER EXTRACTED FROM THE ZIP FILE AND SELECT USB-I2C\_WDM.INF**

Then hit "Open" and "Next" several times. The hardware wizard should indicate that files are being copied. After file transfer, the hardware wizard should indicate that the new hardware is ready to use.

# Application Note 1590

## Run the ISL95871C Application

ISL95871C should now appear in your START/ALL Programs list. Click on it to run the application. Figure 9 shows a screen shot of the ISL95871C user interface.

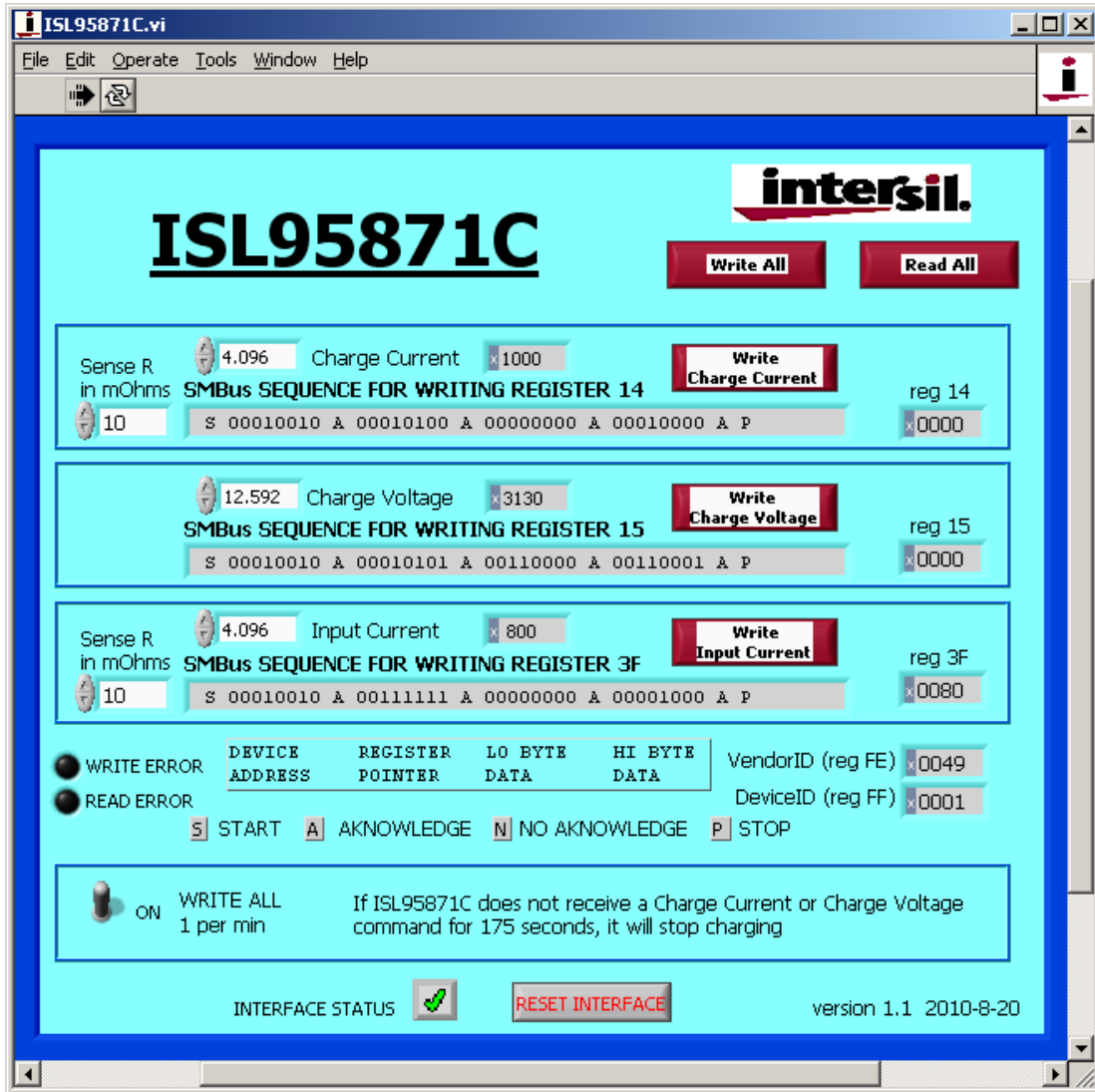

FIGURE 9. ISL95871C CONTROL SOFTWARE SCREEN SHOT

## Enable the Output

When power is applied to the ISL95871C, the Charge Current and Charge Voltage Registers are 0x0000 and the output is disabled. The output is enabled by writing valid, non-zero values to these 2 registers. See the ISL95871C datasheet for valid values.

<http://www.intersil.com/data/fn/fn9258.pdf>

The ISL95871C is also disabled if the ACIN pin is below 3.2V. An Input voltage >13.1V will pull ACIN above 3.2V. The minimum input voltage can be adjusted on the evaluation board by changing R<sub>6</sub> or R<sub>7</sub> (see Figure 14).

## Description of the User Interface Controls and Display Information

Clicking the "Write All" button will write the indicated SMBus sequences to Registers 14, 15, 3F and 44 in the ISL95871C.

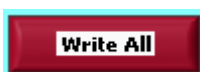

Note: The SMBus part of the ISL95871C and the USB interface are powered by the 5V from the USB port on the PC. It is not necessary to have other power supplies connected to the evaluation board to read or write to the ISL95871C.

Clicking on the "Read All" button will read all 6 registers in the ISL95871C and display the results in the grey indicators below the Read All button.



If the device and the interface are operating normally, the VendorID (reg FE) and the DeviceID (reg FF) will display as follows:

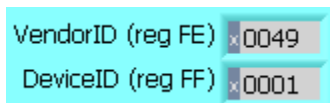

If the VendorID (reg FE) and DeviceID (reg FF) remain 0000 it indicates a communication problem.

If the Visa resource name is blank, it indicates a problem with the USB communication.

Clicking on the "RESET INTERFACE" button may correct the problem. If not, try closing the software, remove power and USB connections from the evaluation board, then reconnect and restart.

Note the register contents are updated ONLY when the Read All button is clicked.



The Write Charge Current Button sends only the charge current to the ISL95871C. Other registers are unchanged.

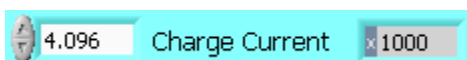

The small white window next to "Charge Current" accepts inputs in Amps, and converts them the hexadecimal (hex) value to be written to the ISL95871C in the grey window. The hex value depends on the value entered in Sense R. The value in the white window will be forced to the nearest valid number that can be produced by the DAC in the ISL95871C. That is, after entering 4 and hitting the enter key, the display will change to 3.968. After entering 4.1 and hitting the enter key, the display will change to 4.096. The value can be incremented and decremented with the up/down arrows at the left of the window.

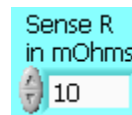

The Sense R inputs are used to calculate the hexadecimal (hex) values and the SMBus sequences for the Charge Current limit and Input Current limit entered in the white boxes. The evaluation board is built with 10mΩ sense resistors. If you change them to another value, enter the new value to get correct calculations.

After entering a number in the white box, hitting the enter key or clicking on another area will enter the value and the resulting hex value and the SMBus sequence will be calculated and displayed.

S = the Start condition, A = the Acknowledge, P = the Stop condition.

Note: The LO byte is sent first. The HI byte is sent second.

When writing 0x41A0, 0xA0 is written first and 0x41 is sent second.

**Important Note: The SMBus commands are NOT sent until one of the WRITE buttons is clicked (i.e. Write All or Write Charge Current)**

The Write Charge Voltage button writes only the Charge Voltage register. Other registers are unchanged.

The small white window accepts Charge Voltage (in Volts) and calculates the hexadecimal value and the SMBus sequence to write to the ISL95871C. The SMBus command is sent when the Write Charge Voltage or Write All button is clicked. See Figure 10.

The Write Input Current button writes only the Charge Voltage register. Other registers are unchanged. The small white window accepts Input Current Limit in Amps and calculates the hex value and the SMBus sequence to be written to the ISL95871C. The Sense R input is used to calculate the hex value and the SMBus sequence. The SMBus command is sent when the Write Input Current or Write All button is clicked. See Figure 11.

The ISL95871C will shut down unless it receives Charge Voltage or Charge Current commands every 175s. This is a safety feature that prevents overcharging batteries if bus master has stopped functioning. The software can write all commands to the ISL95871C every 60s to prevent the time-out. See Figure 12.

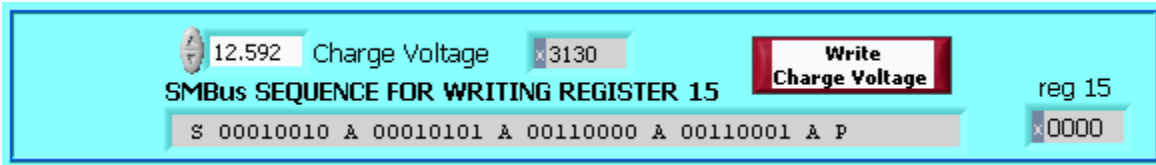

**FIGURE 10. WRITE CHARGE VOLTAGE BUTTON**



**FIGURE 11. WRITE INPUT CURRENT BUTTON**

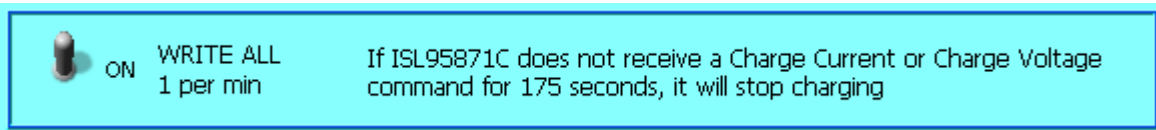

**FIGURE 12. WRITE ALL EVERY 60 SECONDS BUTTON**

## Interface Troubleshooting

When the ISL95871CEVAL3Z evaluation board is connected to the PC by a USB cable and the software is running, the software opens a logical connection to the micro-controller on the eval board. If there is a problem with this connection an "X" will appear in the INTERFACE STATUS box to indicate a problem with communication between the PC and the micro controller on the evaluation board. Check and correct the connection of the USB cable to your PC and the evaluation board. Click on the "RESET INTERFACE" button.

If the interface status still has an "X", Close and restart the ISL95871C control software.

If you still get an "X", Open the Device Manager (Control Panel/System/Device Manager) with the ISL95871CEVAL3Z evaluation board connected to your USB port. You should see a device named "NI-VISA USB Device". If it is not in the list of devices, the driver may not be correctly installed. Run the New Hardware wizard.

If you still get an "X", contact your Intersil Field Application Engineer for assistance.





# ISL95871CEVAL3Z Evaluation Board Schematics

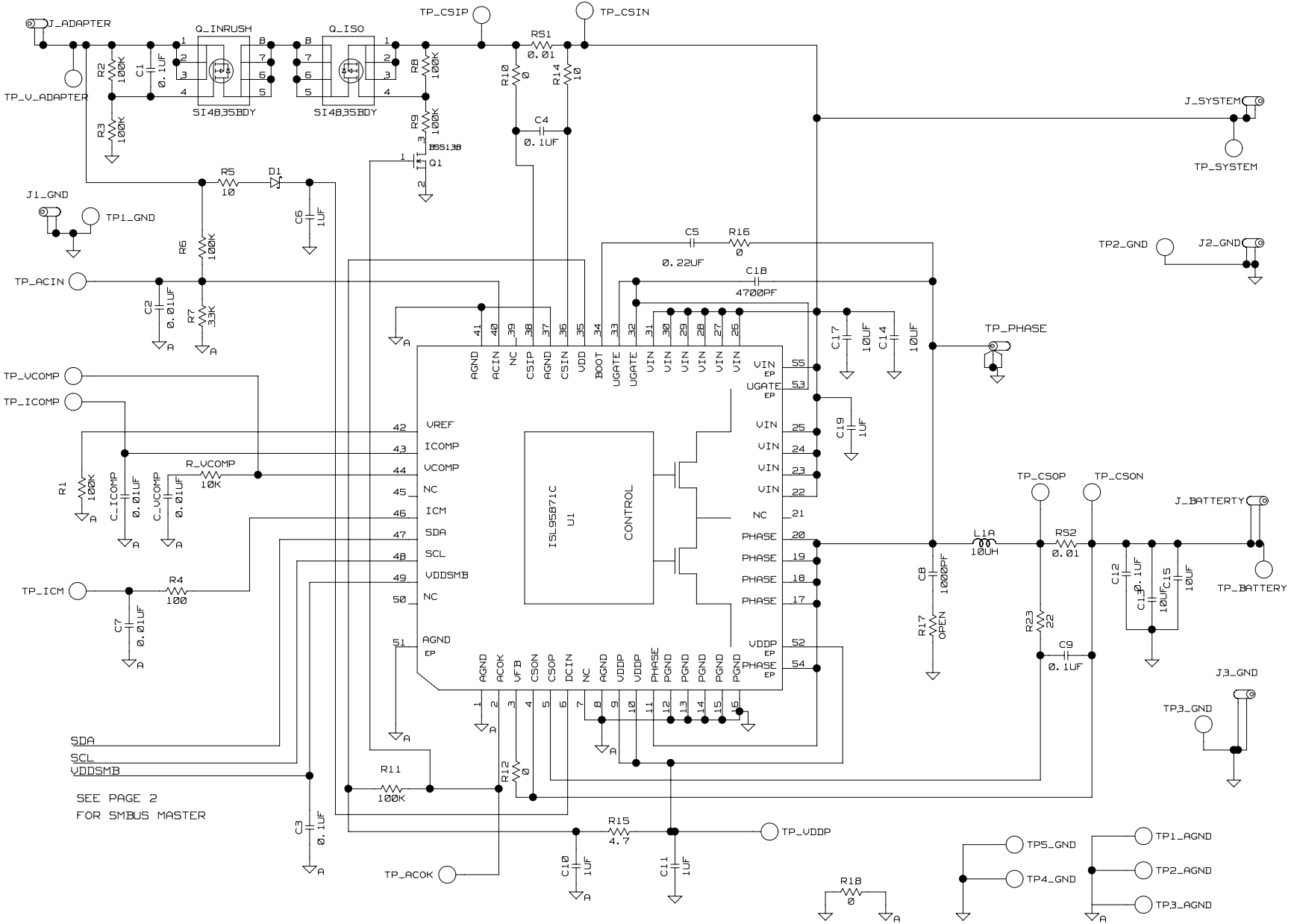
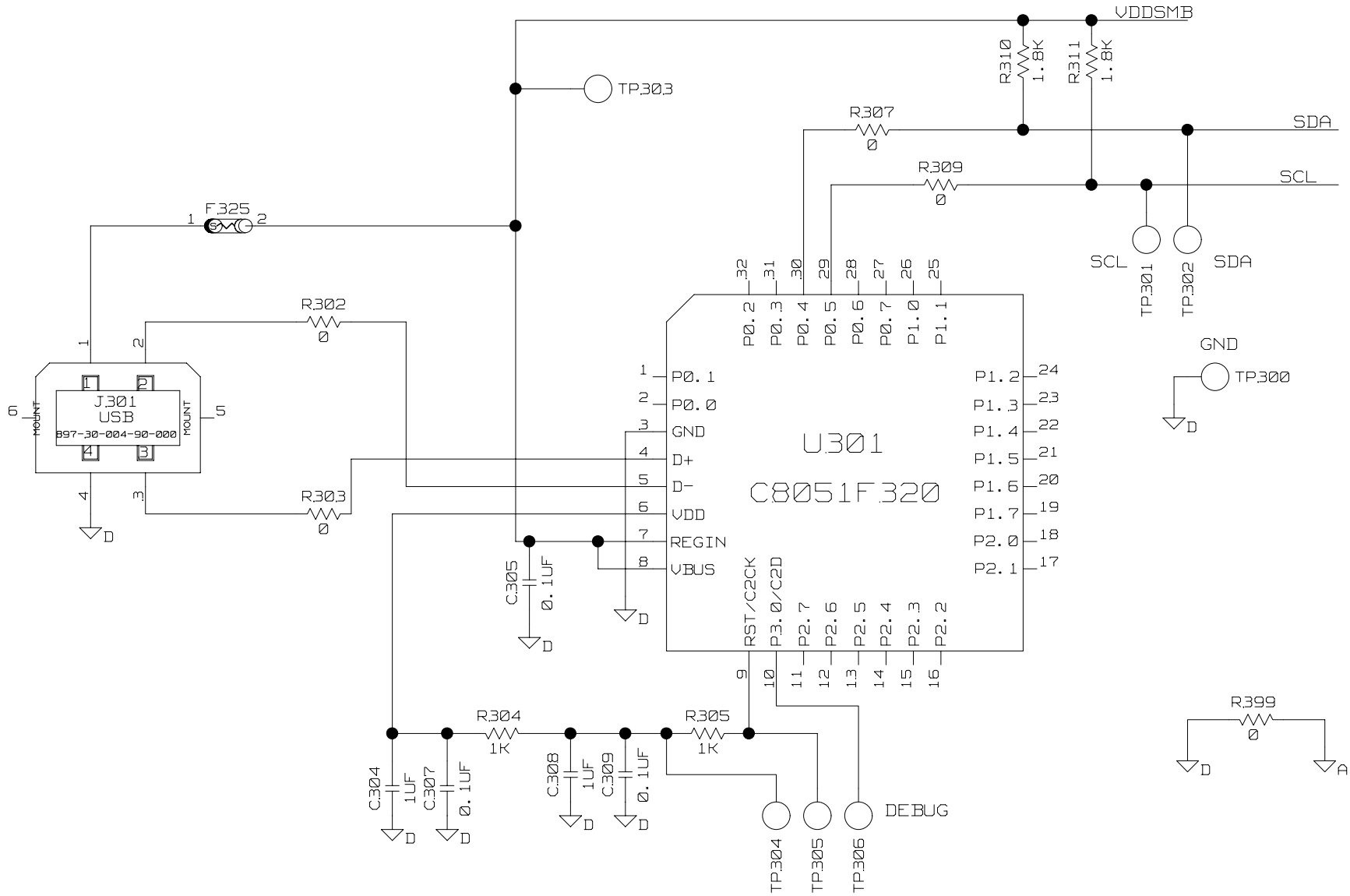

FIGURE 13. ISL95871CEVAL3Z EVALUATION BOARD SCHEMATIC

# ISL95871CEVAL3Z Evaluation Board Schematics (Continued)



**FIGURE 14. ISL95871CEVAL3Z EVALUATION BOARD SCHEMATIC (USB - SMBUS INTERFACE)**

# Application Note 1590

**TABLE 1. BILL OF MATERIALS**

REF DES	PART NUMBER	VALUE	MANUFACTURER	DESCRIPTION
Ref Des	Part Number	VALUE	MANUFACTURER	DESCRIPTION
C1	H1045-00104-25V10	0.1µF	GENERIC	Multilayer Cap
C10, C11	H1045-00105-6R3V10	1µF	GENERIC	Multilayer Cap
C13, C14, C15, C17	H1065-00106-25V20	10µF	GENERIC	Multilayer Cap
C18	H1045-00472-50V5	4700PF	GENERIC	Multilayer Cap
C2, C7, C_ICOMP, C_VCOMP	H1045-00103-25V10	0.01µF	GENERIC	Multilayer Cap
C3, C12	C1608X7R1H104M	0.1µF	TDK	MULTILAYER CAP
C304, C308	H1045-00105-6R3V10	1µF	GENERIC	Multilayer Cap
C305, C307, C309	H1045-00104-16V10	0.1µF	GENERIC	Multilayer Cap
C4, C9	H1045-00104-25V10	0.1µF	GENERIC	Multilayer Cap
C5	H1045-00224-25V20	0.22µF	GENERIC	Multilayer Cap
C6, C19	H1046-00105-25V10	1µF	GENERIC	Multilayer Cap
C8	H1045-00102-50V10	1000PF	GENERIC	Multilayer Cap
D1	BAT54		DIODES	30V SCHOTTKY DIODE
F325	MICROSMD050F		RAYCHEM-TYCO	PolySwitch SM Resettable Fuse
J_ADAPTER, J_BATTERY, J_SYSTEM	164-6219		MOUSER	Single Point RA PCB Mount (Red)
J1_GND, J2_GND, J3_GND	164-6218		MOUSER	Single Point RA PCB Mount (Black)
J301	897-30-004-90-000		MIL-MAX	Type B Receptacle USB Connector
L1A	IHLP-2525CZ-RZ10RM01	10µH	VISHAY	Low Profile High Current Ind
Q_INRUSH, Q_ISO	SI4835BDY		VISHAY	30V -7.4A P-Channel MOSFET
Q1	BSS138		DIODES-INC	200mA 50V N-Channel Transistor
R_VCOMP	H2511-01002-1/10W5	10k	GENERIC	Thick Film Chip Resistor
R1, R6, R11	H2511-01003-1/10W5	100k	GENERIC	Thick Film Chip Resistor
R10, R12, R16	H2511-00R00-1/16W1	0	GENERIC	Thick Film Chip Resistor
R14	H2511-00100-1/16W5	10	GENERIC	Thick Film Chip Resistor
R15	H2511-004R7-1/16W5	4.7	GENERIC	Thick Film Chip Resistor
R17	H2514-ROPEN-OPEN	OPEN	GENERIC	Thick Film Chip Resistor
R18	H2511-00R00-1/16W	0	GENERIC	Thick Film Chip Resistor
R2, R3, R8, R9	H2511-01003-1/16W1	100k	GENERIC	Thick Film Chip Resistor
R23	H2511-00220-1/16W5	22	GENERIC	Thick Film Chip Resistor
R302, R303, R307, R309, R399	H2511-00R00-1/16W1	0	GENERIC	Thick Film Chip Resistor
R304, R305	H2511-01001-1/16W1	1k	GENERIC	Thick Film Chip Resistor
R310, R311	H2511-01801-1/16W5	1.8k	GENERIC	Thick Film Chip Resistor
R4	H2511-01000-1/16W1	100	GENERIC	Thick Film Chip Resistor
R5	H2511-00100-1/16W5	10	GENERIC	Thick Film Chip Resistor
R7	H2511-03302-1/16W5	33k	GENERIC	Thick Film Chip Resistor
RS1, RS2	WSL2512R0100FEA	0.01	VISHAY	POWER METAL STRIP RESISTOR

## Application Note 1590

**TABLE 1. BILL OF MATERIALS (Continued)**

REF DES	PART NUMBER	VALUE	MANUFACTURER	DESCRIPTION
TP_ACIN, TP_ACOK, TP_ICM, TP_ICOMP, TP_VCOMP, TP_VDDP	5009		KEystone	Compact Yellow Test Point 0.070 Pad 0.041 Thole
TP_BATTERY, TP_SYSTEM, TP_V_ADAPTER	5005		KEystone	Compact Red Test Point 0.070 Pad 0.041 Thole
TP_PHASE	131-4353-00		TEKTRONIX	Scope Probe Test Point PCB Mount
TP1_AGND, TP1_GND, TP2_AGND, TP2_GND, TP3_AGND, TP3_GND, TP4_GND, TP5_GND, TP_CSON	5006		KEystone	Compact Black Test Point 0.070 Pad 0.041 Thole
TP300, TP301, TP302, TP303, TP304, TP305, TP306, TP_CSIN, TP_CSIP, TP_CSOP	5007		KEystone	Compact White Test Point 0.070 Pad 0.041 Thole
U1	ISL95871C		INTERSIL	SMBus INTERFACED BATTERY CHARGER WITH INTERNAL FETs
U301	C8051F320		SILICON LABRATORIES	General Purpose MicroControllers

# ISL95871CEVAL3Z Evaluation Board Layout

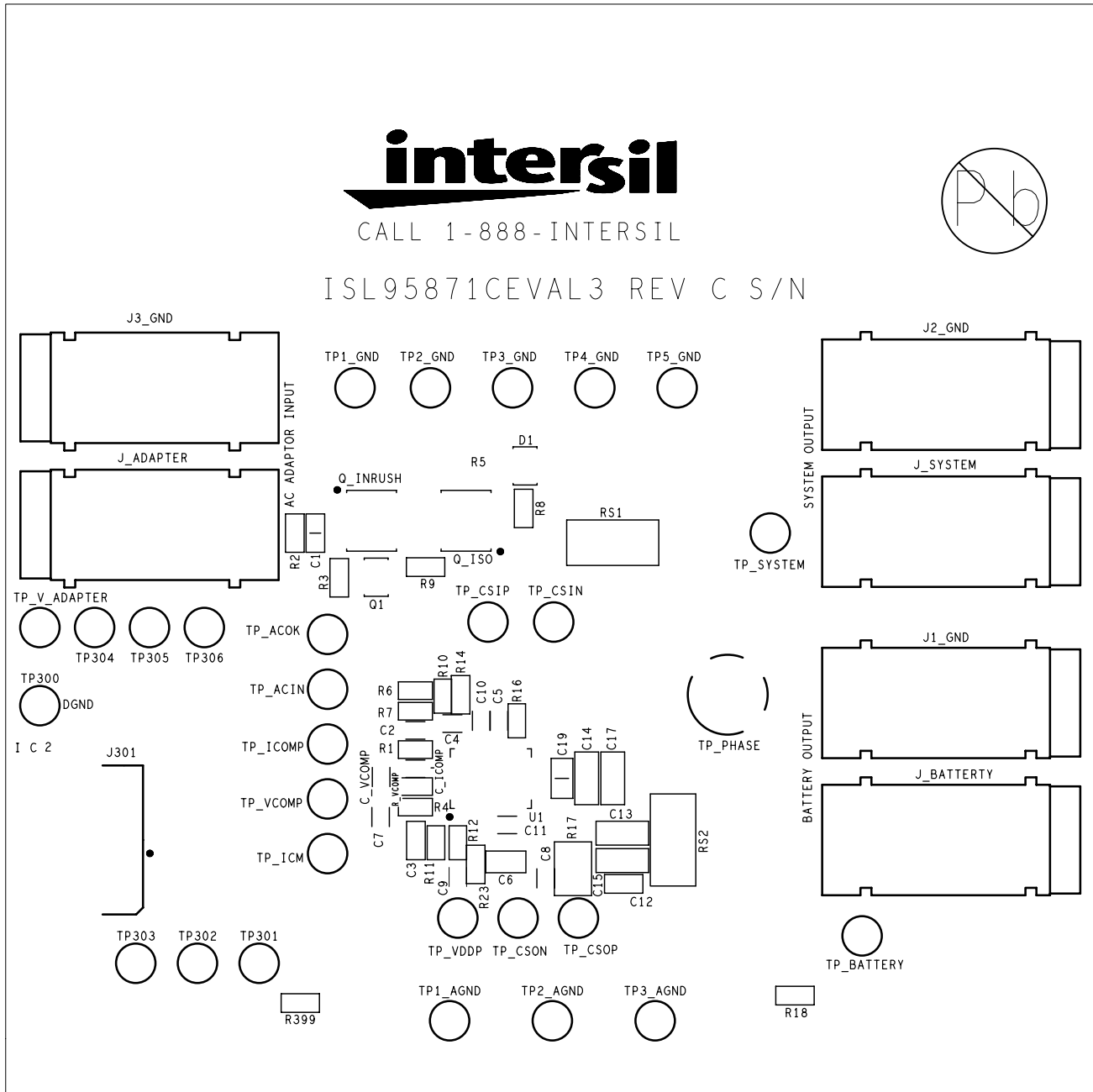

FIGURE 15. TOP SILK

ISL95871CEVAL3Z Evaluation Board Layout (Continued)

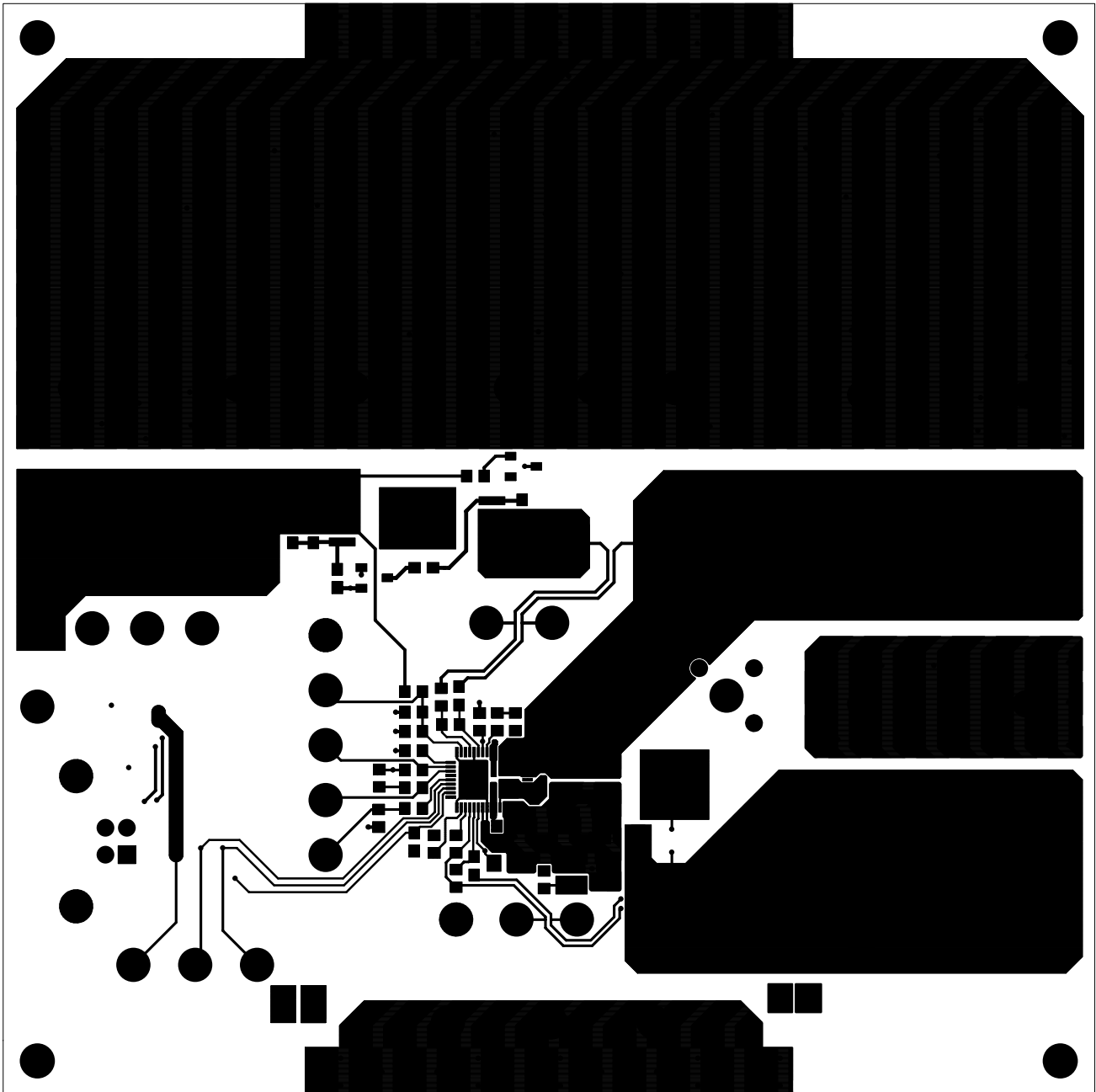

FIGURE 16. LAYER 1 (TOP) COPPER

ISL95871CEVAL3Z Evaluation Board Layout (Continued)

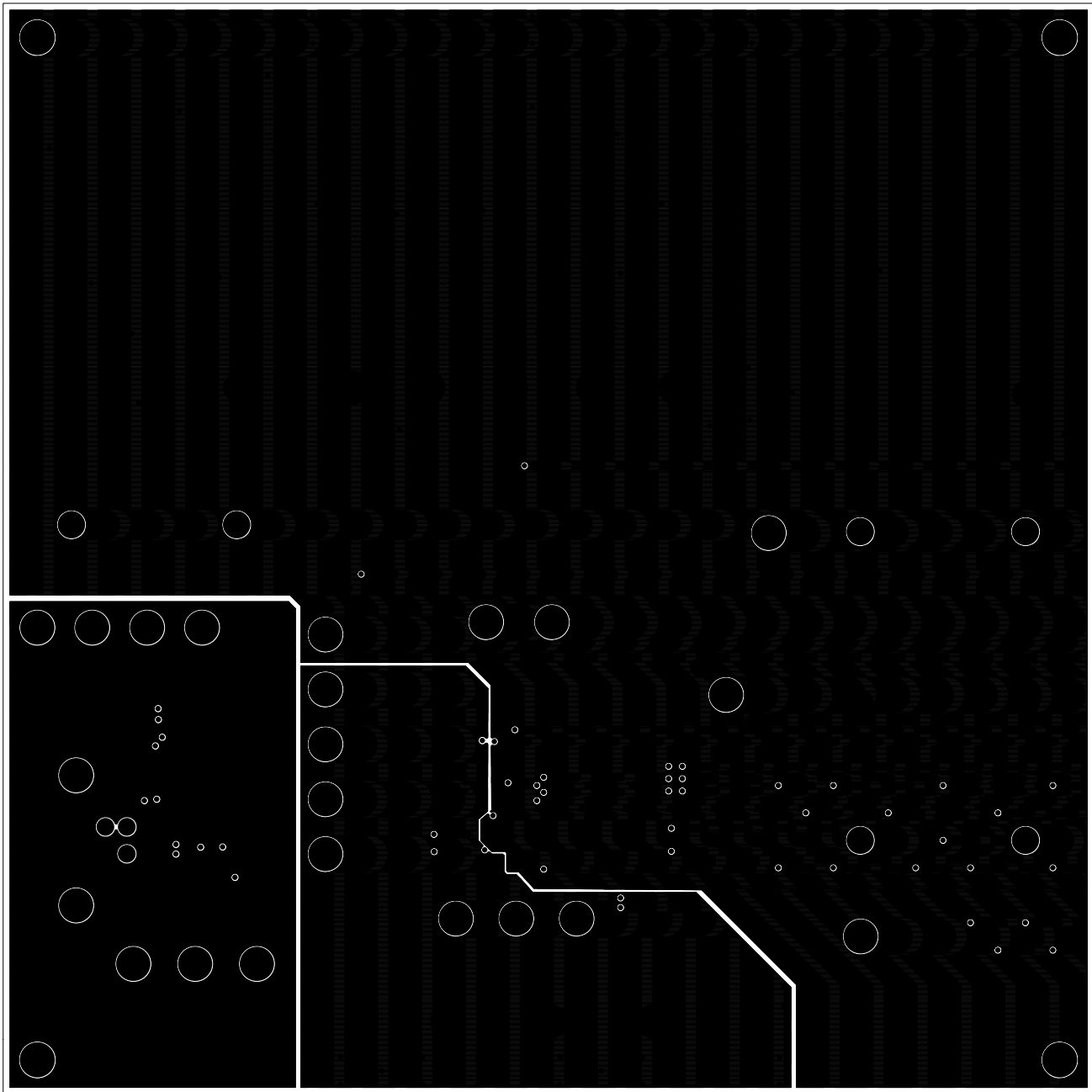

FIGURE 17. LAYER 2 COPPER

ISL95871CEVAL3Z Evaluation Board Layout (Continued)

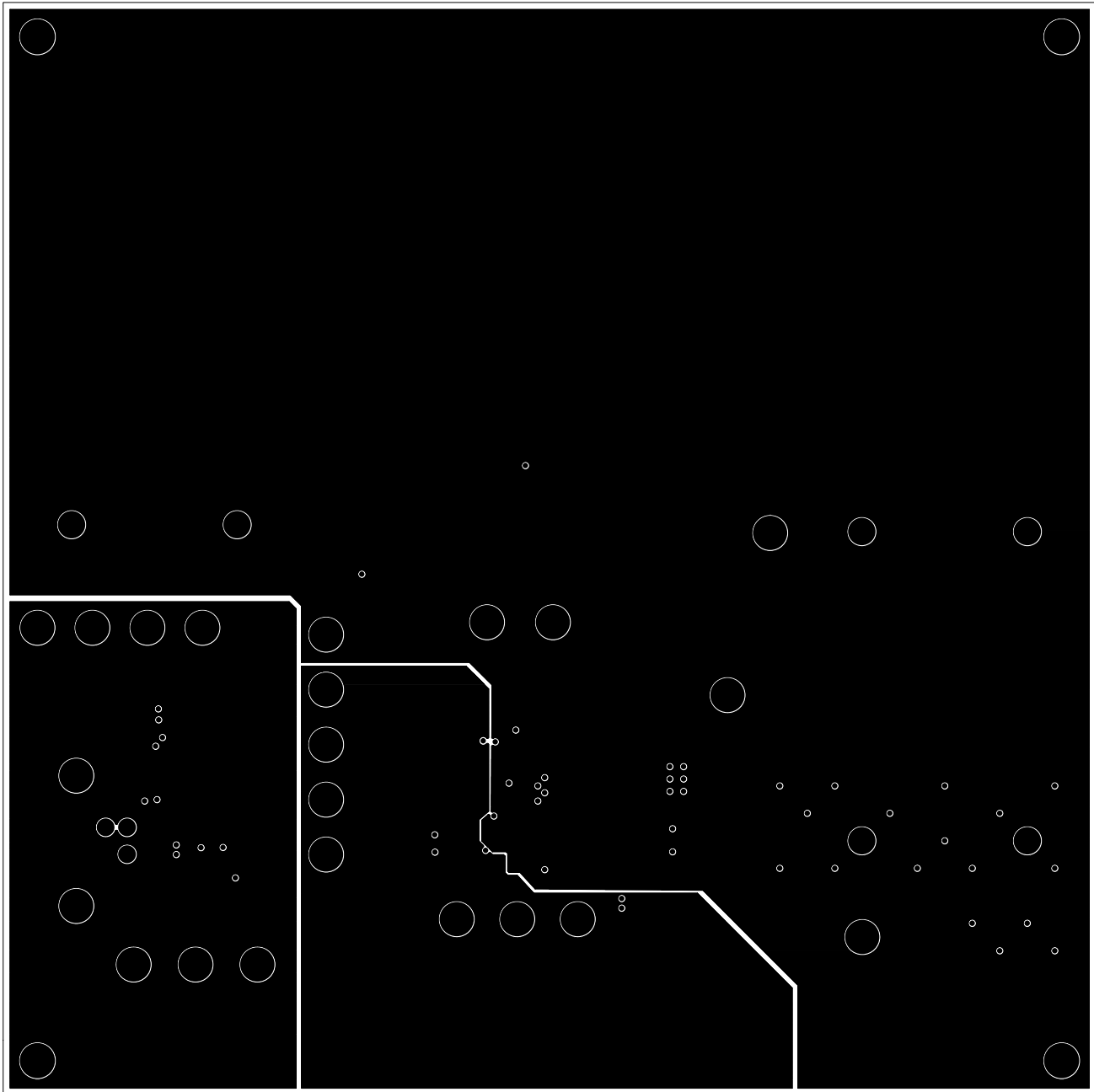

FIGURE 18. LAYER 3 COPPER



ISL95871CEVAL3Z Evaluation Board Layout (Continued)

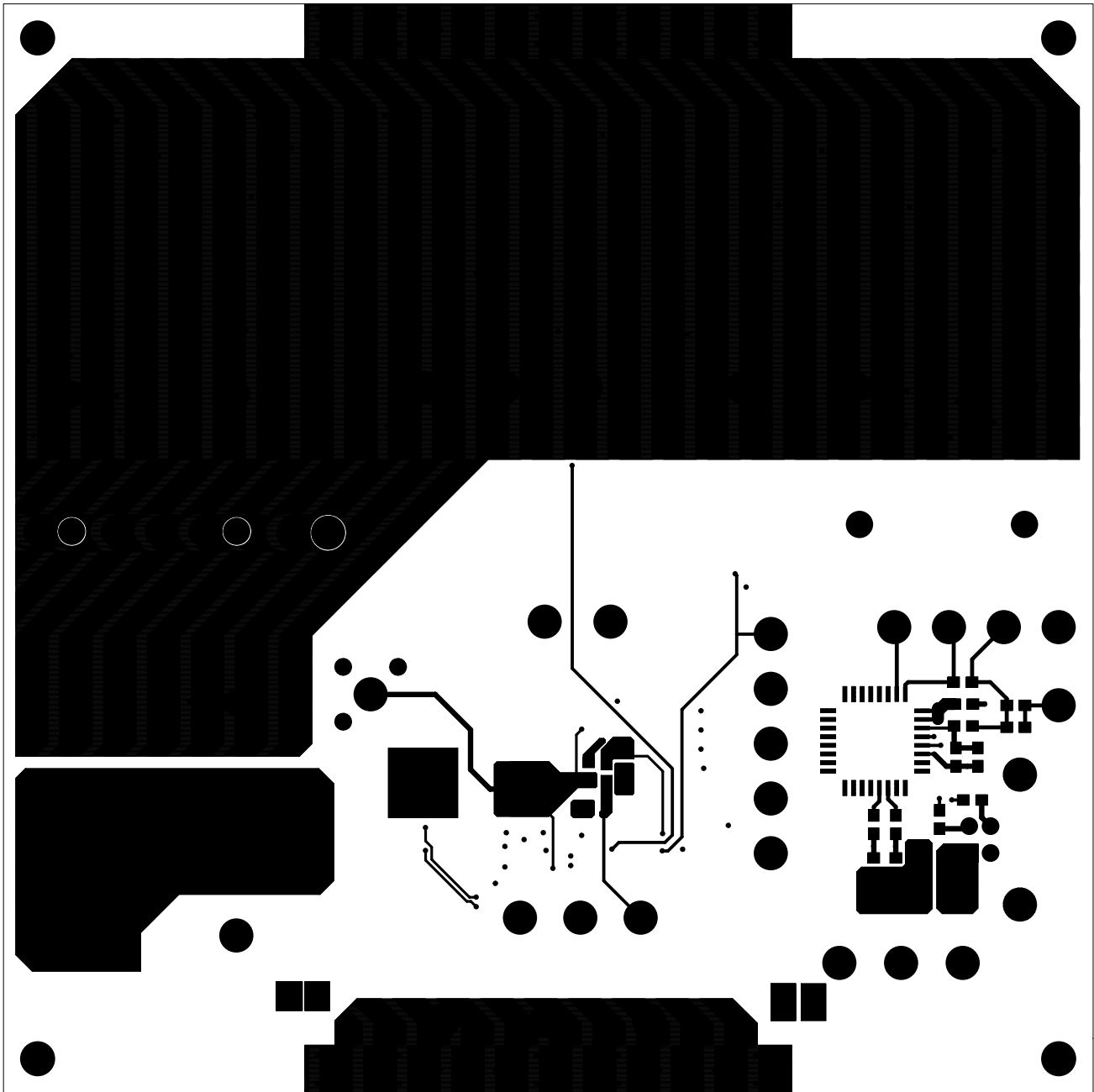

FIGURE 19. LAYER 4 (BOTTOM) COPPER

ISL95871CEVAL3Z Evaluation Board Layout (Continued)

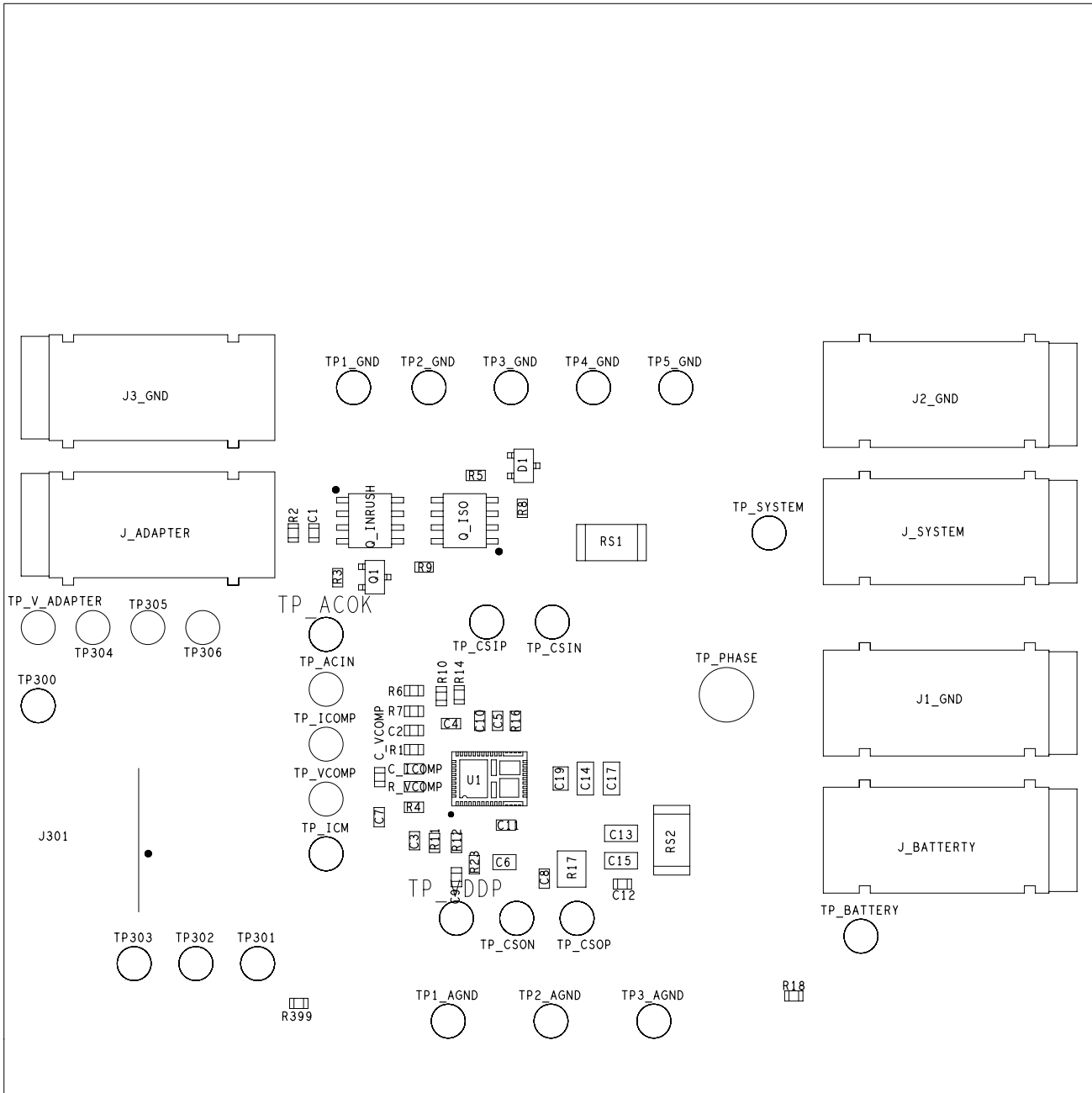

FIGURE 20. BOTTOM SILK SCREEN (VIEWED FROM THE BOTTOM)

Intersil Corporation reserves the right to make changes in circuit design, software and/or specifications at any time without notice. Accordingly, the reader is cautioned to verify that the Application Note or Technical Brief is current before proceeding.

For information regarding Intersil Corporation and its products, see [www.intersil.com](http://www.intersil.com)